



IQS133 Datasheet

IQ Switch® - ProxSense® Series

Minimalist 3 Channel Capacitive Sensor with Compensation for Sensitivity Reducing Objects

Unparalleled Features

- Sub 4uA current consumption
- Automatic tuning for optimal operation in various environments & compensation against sensitivity reducing objects

The IQS133 ProxSense® IC is a fully integrated three channel capacitive contact and proximity sensor with market leading sensitivity and automatic tuning of the sense electrodes. The IQS133 provides a minimalist implementation requiring as few as 2 external components. The device is ready for use in a large range of applications while programming options allow customisation in specialized applications.

Main Features

- 3 Channel input device
- Differentiated Touch & Proximity Output
- ATI: Automatic tuning to optimum sensitivity
- Supply Voltage 3V to 5V
- Internal voltage regulator and reference capacitor
- OTP options
 - ❖ Direct (logic level) and serial data output
 - ❖ Low Power Modes (sub 4µA min)
 - ❖ Proximity & Touch Thresholds
- Automatic drift compensation
- Development and Programming tools available (USBProg)
- Small outline MSOP-10

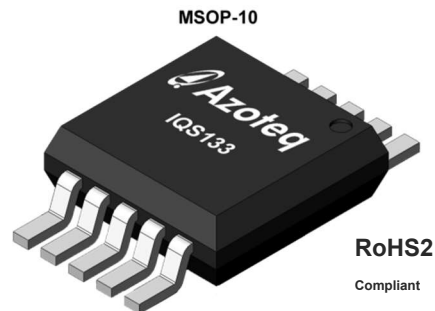

MSOP-10

Representations only,
not actual markings

Applications

- White goods and appliances
- Remote Controls
- Office equipment, toys, sanitary ware
- Flame proof, hazardous environment Human Interface Devices
- Proximity detection that enables backlighting activation (Patented)
- Wake-up from standby applications
- Replacement for electromechanical switches
- GUI trigger on proximity detection.

Available options

T _A	MSOP-10
-40°C to 85°C	IQS133



Contents

IQS133 DATASHEET	1
FUNCTIONAL OVERVIEW	3
1 INTRODUCTION	3
2 ANALOGUE FUNCTIONALITY.....	3
3 DIGITAL FUNCTIONALITY	4
4 REFERENCE DESIGN	5
5 HIGH SENSITIVITY.....	6
6 USER CONFIGURABLE OPTIONS.....	6
7 DESCRIPTION OF USER OPTIONS	10
8 CHARGE TRANSFERS.....	13
9 DATA STREAMING	14
10 AUTO TUNING IMPLEMENTATION (ATI)	15
11 SPECIFICATIONS	17
12 MECHANICAL DIMENSIONS.....	20
13 DEVICE MARKING	22
14 ORDERING INFORMATION	23
15 REVISION HISTORY	24
APPENDIX A. CONTACT INFORMATION.....	ERROR! BOOKMARK NOT DEFINED.



Functional Overview

1 Introduction

The IQS133 is a three channel capacitive proximity and touch sensor featuring internal voltage regular and reference capacitor (C_s).

The device has three dedicated input pins for the connection of the sense electrodes (C_x). Three output pins for Touch (for each channel) detection and one output (POUT) for proximity detection. The output pins can be configured as Logic outputs or in a serial data streaming option on TO0.

The device automatically tracks slow varying environmental changes via various filters, detect noise and has an Automatic Tuning Implementation (ATI) to tune the device for optimal sensitivity.

1.1 Pin-outs

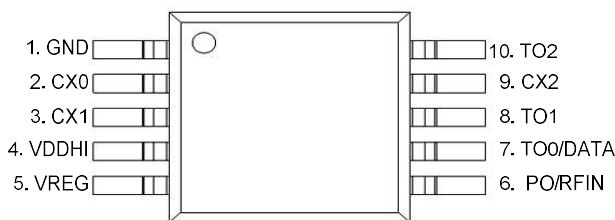

Figure 1.1 IQS133 Pin-outs

Table 1.1 IQS133 Pin-outs.

Pin	Standalone	Streaming	Function
1	GND	GND	Ground
2	CX0	CX0	Sense Electrode
3	CX1	CX1	Sense Electrode
4	VDDHI	VDDHI	Power Input
5	VREG	VREG	Regulator Pin
6	PO		Proximity Output
7	TO0	DATA	Touch Output
8	TO1		Touch Output
9	CX2	CX2	Sense Electrode
10	TO2		Touch Output

1.2 Applicability

All specifications, except where specifically mentioned otherwise, provided by this datasheet are applicable to the following ranges:

- Temperature -40C to +85C
- Supply voltage (V_{DDHI}) 3V to 5.5V

2 Analogue Functionality

The analogue circuitry measures the capacitance of the sense electrodes attached to the C_x pins through a charge transfer process that is periodically initiated by the digital circuitry. The measuring process is referred to as a conversion and consists of the discharging of C_s and C_x , the charging of C_x



and then a series of charge transfers from C_x to C_s until a trip voltage is reached. The number of charge transfers required to reach the trip voltage is referred to as the Count Values (CS).

The capacitance measurement circuitry makes use of an internal C_s and voltage reference (V_{REG}).

The analogue circuitry further provides functionality for:

- Power on reset (POR) detection.
- Brown out detection (BOD).

3 Digital Functionality

The digital processing functionality is responsible for:

- Device configuration from OTP settings after POR.
- Management of BOD and WDT events.
- Initiation of conversions at the selected rate.
- Processing of CS and execution of algorithms.
- Monitoring and automatic execution of the ATI algorithm.
- Signal processing and digital filtering.
- Detection of PROX and TOUCH events.
- Managing outputs of the device.
- Managing serial communications.
- Manage programming of OTP options.



4 Reference Design

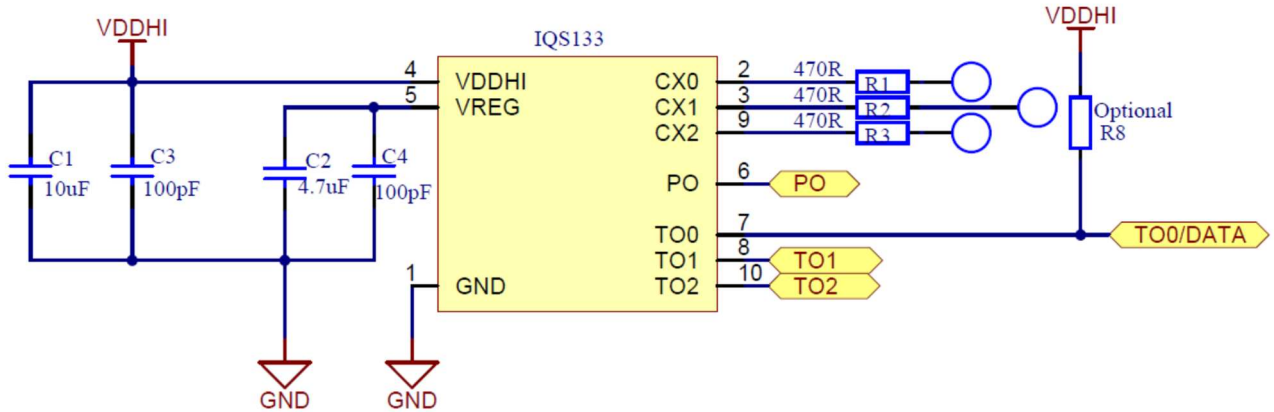

- LEDs used in active low mode
- Use R4-R7 for current limiting on I/Os

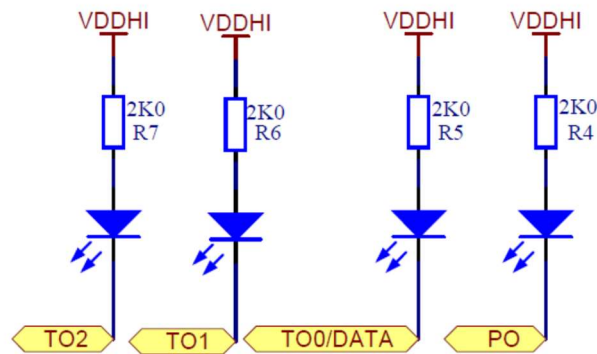

Figure 4.1 Reference Design for IQS133. Output in active Low.

- Use C3 and C4 for added RF immunity.
- External pull-up (10k) on TOUT0/DATA required when used in Data streaming mode.
- Place C1-C4 as close as possible to IC, connected to good GND.



5 High Sensitivity

Through patented design and advanced signal processing, the device is able to provide extremely high sensitivity to detect Proximity. This enables designs to detect proximities at distances that cannot be equalled by most other products. When the device is used in environments where noise or ground effects exist that lower the sensitivity, a reduced proximity threshold is proposed to ensure reliable functioning of the sensor.

6 User Configurable Options

The IQS133 provides One Time Programmable (OTP) user options (each option can be modified only once). The device is fully functional in the default (unconfigured) state. OTP options are intended for specific applications.

The configuration of the device can be done on packaged devices or in-circuit. In-circuit configuration may be limited by values of external components chosen.

6.1 Configuring of Devices

Azoteq offers a Configuration Tool (CTxxx) and accompanying software (USBProg.exe)

that can be used to program the OTP user options for prototyping purposes. More details regarding the configuration of the device with the USBProg program is explained by application note: “AZD007 – USBProg Overview” which can be found on the Azoteq website.

Alternate programming solutions of the IQS133 also exist. For further enquiries regarding this matter please contact Azoteq at ProxSenseSupport@azoteq.com or the local distributor. Table 6-6.1: User Selectable Configuration Options: Bank 0



P_{MODE2}	P_{MODE1}	P_{MODE0}	T_{THR2}	T_{THR1}	T_{THR0}	P_{THR1}	P_{THR0}
-------------	-------------	-------------	------------	------------	------------	------------	------------

bit 7

bit 0

Bank 0: bit 7-5 **P_{MODE2} : P_{MODE0} :**Power Modes

Section 7.4

000 = Boost Power Mode

001 = Normal Power Mode

010 = Low Power Mode 1

011 = Low Power Mode 2

100 = Low Power Mode 3

101 = Low Power Mode 4

110 = Low Power Mode 5

111 = Low Power Mode 6

Bank 0: bit 4-2 **T_{THR2} : T_{THR0} :** Touch Thresholds on CH0 & CH2

Section 7.2

000 = 4/64

001 = 1/64 (Most Sensitive)

010 = 2/64

011 = 8/64

100 = 12/64

101 = 16/64

110 = 24/64

111 = 32/64 (Least Sensitive)

Bank 0: bit 1-0 **P_{THR1} : P_{THR0} :**Proximity Thresholds

Section 7.1

00 = 2 (Most Sensitive, 4 for IQS133Z)

01 = 4 (2 for IQS133Z)

10 = 8

11 = 16 (Least Sensitive)



Table 6-6.2: User Selectable Configuration Options: Bank 1

t_{HALT1}	t_{HALT0}	ATI	CH1 T_{TH2}	CH1 T_{TH1}	CH1 T_{TH0}	BASE1	BASE0
--------------------	--------------------	-----	----------------------	----------------------	----------------------	-------	-------

bit 7

bit 0

Bank 1: bit 7-6 $t_{\text{HALT1}}:t_{\text{HALT0}}$: Halt time of Long Term Average Section 7.67.5

00 = 20 seconds

01 = 40 seconds

10 = Always

11 = Always (Prox on 40)

Bank 1: bit 5 **ATI**: ATI Select Section 10.2

0 = Full

1 = Partial

Bank 1: bit 4-2 **CH1 T_{TH2} :CH1 T_{TH0}** : Touch Thresholds on CH1 Section 7.2 & Section 10.2

000 = 4/64

001 = 1/64 (Most Sensitive)

010 = 2/64

011 = 8/64

100 = 12/64

101 = 16/64

110 = 24/64

111 = 32/64 (Least Sensitive)

Bank 1: bit 1-0 **BASE1:BASE0**: Proximity CH Base Value Section 7.5

00 = 200

01 = 50

10 = 100

11 = 250



Table 6-6.3: User Selectable Configuration Options: Bank 2

		STREAMING	ND LEVEL	ND		CX1 Block	LOGIC
--	--	-----------	----------	----	--	-----------	-------

bit 7							bit 0
	Bank 2: bit 5	STREAMING: 1-wire streaming mode			Section 9.1		
		0 = Disabled					
		1 = Enabled					
	Bank 2: bit 4	ND LEVEL: Sets ND level					
		0 = 50mV					
		1 = 25mV					
	Bank 2: bit 3	ND: Noise Detect			Section 7.7		
		0 = Disabled					
		1 = Enabled					
	Bank 2: bit1	CX1 Block: Guard channel enable			Section 0		
		0 = Disabled					
		1 = Enabled					
	Bank 2: bit0	LOGIC: Output logic select			Section 7.3		
		0 = Active Low (Software open drain)					
		1 = Active High					



7 Description of User Options

This section describes the individual user programmable options of the IQS133 in more detail.

A number of standard device configurations are available (refer to Chapter 6). Azoteq can supply pre-configured devices for large quantities.

7.1 Adjustable Proximity Threshold

The IQS133 has 4 proximity threshold settings. The proximity threshold is selected by the designer to obtain the desired sensitivity and noise immunity. The proximity event is triggered based on the selected proximity threshold; the CS and LTA (Long Term Average) The threshold is expressed in terms of counts; the same as CS.

The IQS133Z start with a proximity threshold of the $P_{TH} + 4$ for 15 seconds (as well as $P_{TH} + 4$ when in zoom mode if one of the LP selections are used) from a cold start. After 15 seconds, the proximity threshold will adjust to the value selected by the OTP option.

Configuration: Bank0 bit1-0

PTHR1:PTHR0: Proximity Thresholds

Bit	Selection
00	2 (Most sensitive), (4 for IQS133Z)
01	4 (2 for IQS133Z)
10	8
11	16 (Least sensitive)

7.2 Adjustable Touch Thresholds

The IQS133 has 8 touch threshold settings. The touch threshold is selected by the designer to obtain the desired touch sensitivity. The touch threshold is expressed as a fraction of the LTA as follows:

$$T_{TH} = \text{Selected Touch Threshold} \times LTA$$

Where LTA is the Long Term Average

The touch event is triggered based on T_{TH} , CS and LTA. A touch event is identified when for at least 4 consecutive samples of the following equation holds:

$$T_{TH} \leq LTA - CS$$

With lower average CS (therefore lower LTA) values the touch threshold will be lower and vice versa. The Touch Threshold for CH0 & CH2 are set as follow:

Configuration: Bank0 bit 4-2

TTHR0:TTHR2: Touch Thresholds

Bit	Selection
000	4/64
001	1/64 (Most sensitive)
010	2/64
011	8/64
100	12/64
101	16/64
110	24/64
111	32/64 (Least sensitive)

The Touch Threshold for CH1 is set as follow:

Configuration: Bank1 bit 4-2

TTHR0:TTHR2: Touch Thresholds

Bit	Selection
000	4/64
001	1/64 (Most sensitive)
010	2/64
011	8/64
100	12/64
101	16/64
110	24/64
111	32/64 (Least sensitive)

7.3 Logic Output

The IQS133 can be set to sink or source current in stand-alone mode, by setting the logic output active high or active low.



Configuration: Bank2 bit0

Logic: Output Logic Select	
Bit	Selection
0	Active Low (Software open drain)
1	Active High

7.4 Power Modes

The IQS133 IC has eight power modes specifically designed to reduce current consumption for battery applications.

The power modes are implemented around the occurrence of charge cycle every t_{SAMPLE} seconds (refer to Table 7.1). Lower sampling frequencies yield lower power consumption (but decreased response time).

During normal operation charge cycles are initiated approximately every 50ms. This is referred to as Normal Power Mode (NP). The IQS133 by default charges in Boost Power Mode.

The timings for all the Power Modes are provided in the table below. While in any power mode the device will zoom to BP whenever the counts (CS) indicate a possible proximity or touch event. This improves the response time. The device will remain in BP for t_{ZOOM} seconds and then return to the selected power mode. The Zoom function allows reliable detection of events with counts being produced at the BP rate.

Table 7.1 Power Mode timings

Power Mode timing	t_{SAMPLE} (ms)
t_{BP} (default)	5
t_{NP}	50
t_{LP1}	256
t_{LP2}	512
t_{LP3}	768
t_{LP4}	1000
t_{LP5}	1500
t_{LP6}	2000

Configuration: Bank0 bit7-5

PMODE0:PMODE1: Power Modes	
Bit	Selection
000	Boost Power Mode (BP)
001	Normal Power Mode (NP)
010	Low Power Mode 1 (LP1)
011	Low Power Mode 2 (LP2)
100	Low Power Mode 3 (LP3)
101	Low Power Mode 4 (LP4)
110	Low Power Mode 5 (LP5)
111	Low Power Mode 6 (LP6)

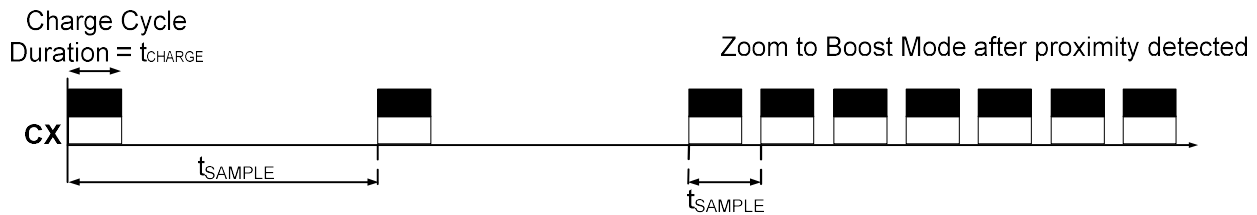

Figure 7.1 LP Modes: Charge cycles

7.5 ATI Base Value

The sensitivity gain of the Proximity channel can be set by adjusting the Base Value of the ATI algorithm. Decreasing the base from 200 to 150 or even 50 will increase the sensitivity and vice versa. By decreasing the base value, the analog gain from the sensor is increased.

Configuration: Bank1 bit1-0

BASE1:BASE0: Proximity Base Value	
Bit	Selection
00	200
01	50
10	100
11	250

7.6 Filters used by the IQS133

The IQS133 devices employ various signal processing functions that includes the execution of various filters as described below.

7.6.1 Long Term Average (LTA)

Capacitive touch devices detect changes in capacitance that are not always related to the intended proximity or touch of a human. This is a result of changes in the environment of the sense plate and other factors. These changes need to be compensated for in various manners in order to reliably detect touch events and especially to detect proximity events. One mechanism the IQS133 employs is the use of a Long Term Averaging filter (IIR type filter) which tracks slow changes in the environment (expressed as changes in the counts). The result of this filter is a Long Term Average (LTA) value that forms a dynamic reference used for various

functions such as identification of proximity and touch events.

The LTA is calculated from the counts (CS). The filter only executes while no proximity or touch event is detected to ensure compensation only for environmental changes. However there may be instances where sudden changes in the environment or changes in the environment while a proximity or touch event has been detected cause the CS to drift away from the LTA. To compensate for these situations a Halt Timer (t_{HALT}) has been defined.

The Halt Timer is started when a proximity or touch event occurs (for the 133Z, all the channels' filters halt on a proximity event) and when it expires the LTA filter is recalibrated. Recalibration causes $LTA < CS$, thus the disappearance of proximity or touch events.

The designer needs to select a Halt Timer value to best accommodate the required application.

Configuration: Bank1 bit7-6

$t_{HALT1}:t_{HALT0}$: Halt time of Long Term Average	
Bit	Selection
00	20 seconds
01	40 seconds
10	Never
11	ALWAYS (Prox on 40 seconds)

Notes:

- With the Never (bit selection "10") option, the filter will not halt when any proximity or touch condition occurs.
- With the 'ALWAYS' (bit selection "11") option and the detection of a proximity event the execution of the filter will be halted for only 40 seconds and with the detection of a touch event the execution



of the filter will be halted as long as the touch condition applies.

Refer to Application note “AZD024 - Graphical Representation of the IIR Filter” for detail regarding the execution of the LTA filter.

The IQS133 has advanced immunity to RF noise sources such as GSM cellular telephones, DECT, Bluetooth and WIFI devices. Design guidelines should however be followed to ensure the best noise immunity.

Configuration: Bank2 bit3

ND: Noise Detect	
Bit	Selection
0	Disabled
1	Enabled

Notes for layout:

- A ground plane should be placed under the IC, except under the Cx lines
- Place the sensor IC as close as possible to the sense electrodes.
- All the tracks on the PCB must be kept as short as possible.
- The capacitor between VDDHI and GND as well as between VREG and GND, must be placed as close as possible to the IC.
- A 100 pF capacitor can be placed in parallel with the 1uF capacitor between

7.7 Noise Detection

VDDHI and GND. Another 100 pF capacitor can be placed in parallel with the 1uF capacitor between VREG and GND.

- When the device is too sensitive for a specific application a parasitic capacitor (max 5pF) can be added between the Cx line and ground.
- Proper sense electrode and button design principles must be followed.
- Unintentional coupling of sense electrode to ground and other circuitry must be limited by increasing the distance to these sources.
- In some instances a ground plane some distance from the device and sense electrode may provide significant shielding from undesired interference.

When the capacitance between the sense electrode and ground becomes too large the sensitivity of the device may be influenced. For more guidelines on proper layout, please see the application note: “AZD008 - Design Guidelines for Touch Pads” on the Azoteq webpage www.azoteq.com.

7.8 Guard Channel

Configuration: Bank2 bit1

CX1 Block: Guard channel enable	
Bit	Selection
0	Disabled
1	Enabled

When the Guard channel is enabled, the other touch outputs from the device are blocked when a touch condition is detected on CH1 (CH1’s touch output is still active). This can prevent accidental activation when picking up a product, or give a blocking function against water or other environmental factors.

8 Charge Transfers

The IQS133 samples in 4 timeslots, with one internal Cs capacitor. The charge sequence is shown in Figure 8.1, where CH0 is the Prox channel, and charges before each of the 3 input channels. CH0 is realised by connecting all three touch electrodes with internal switches. Therefore: CH0 is a distributed electrode formed by the 3 touch electrodes.

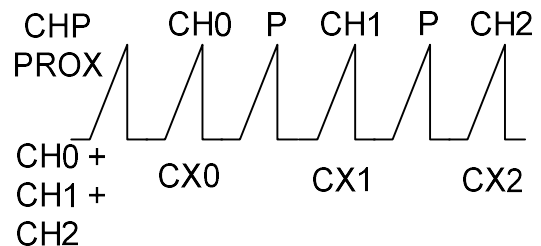

Figure 8.1 Charge Transfer for IQS133.

9 Data Streaming

The IQS133 has the capability to stream data to a MCU. This provides the designer with the capability to obtain the parameters within the device in order to aid design into applications, and debugging systems. Data streaming may further be used by an MCU to control events or further process results obtained from the IQS133. Data streaming is performed as a 1-wire data protocol on one of the output pins (TO0). The functions of all the other output pins are therefore lost when the device is put in streaming mode. Data Streaming can be enabled as indicated below:

9.1 Entering Data Streaming Mode

Configuration: Bank2 bit5

STREAMING: 1-wire data streaming mode

Bit	Selection
0	Disabled
1	Enabled

9.2 Data Streaming Protocol

When data streaming is enabled data is sent following each charge cycle.

Figure 9.1 illustrates the communication protocol for initialising and sending data with the 1 wire communication protocol.

1. Communications is initiated by a START bit. This bit is defined as a low condition for t_{START} .
2. Following the START bit a synchronisation byte ($t_{INIT} = 0xAA$) is sent. This byte is used by the MCU for clock synchronisation.
3. Following t_{INIT} the data bytes will be sent. 8 Bytes will be sent after each charge cycle.
4. Each byte sent will be preceded by a START bit and a STOP bit will follow every byte.
5. A STOP bit is indicated by taking pin 7 high. The STOP bit does not have a defined period.

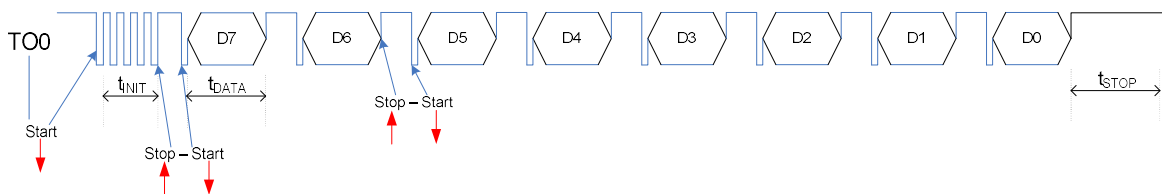

Figure 9.1 1-wire streaming mode



Table 9.1 Byte Definitions for Normal Data Streaming Mode

Byte	Bit	Value
0	7:0	CS High byte
1	15:8	CS Low byte
2	23:16	LTA High byte
3	31:24	LTA Low byte
4	39	ATI busy
	38	RF Noise Detect
	37	Zoom active
	36	LP active
	35	Not used (always 0)
	34	Proximity event CH0
	33	CH Indication(1)
5	32	CH Indication(0)
	47	Not Used
	46	Not Used
	45	Compensation (5)
	44	Compensation (4)
	43	Compensation (3)
	42	Compensation (2)
41	Compensation (1)	

6	40	Compensation (0)
	55	Not Used
	54	Not Used
	53	Not Used
	52	Multiplier (4)
	51	Multiplier (3)
	50	Multiplier (2)
7	49	Multiplier (1)
	48	Multiplier (0)
	63	Not Used
	62	Not Used
	61	Not Used
	60	Not Used
	59	Touch CH 3
58	Touch CH 2	
57	Touch CH 1	
56	Not Used	

In the 4th byte, the channel indication is represented as:

t_{HALT1}:t_{HALT0}:	Halt time of Long Term Average
00	CH P (Distributed Proximity Channel)
01	CH 0 (First Touch Channel)
10	CH 1 (Second Touch Channel)
11	CH 2 (Third Touch Channel)

10 Auto Tuning Implementation (ATI)

ATI is a sophisticated technology implemented in the latest generation ProxSense® devices that optimises the performance of the sensor in a wide range of applications and environmental conditions (refer to application note AZD0027 - Auto Tuning Implementation).

ATI makes adjustments through internal reference capacitors to obtain optimum performance.

ATI adjusts internal circuitry according to two parameters, the ATI multiplier and the ATI

compensation. The ATI multiplier can be viewed as a course adjustment and the ATI compensation as a fine adjustment.

The adjustment of the ATI parameters will result in variations in the counts and sensitivity. Sensitivity can be observed as the change in counts as the result of a fixed change in sensed capacitance. The ATI parameters have been chosen to provide significant overlap. It may therefore be possible to select various combinations of ATI multiplier and ATI compensation settings



to obtain the same count values. The sensitivity of the various options may however be different for the same counts.

10.1 Automatic ATI

The IQS133 implements an automatic ATI algorithm. This algorithm automatically adjusts the ATI parameters to optimise the sense electrodes connection to the device.

The device will execute the ATI algorithm whenever the device starts-up and when the counts are not within a predetermined range.

While the Automatic ATI algorithm is in progress this condition will be indicated in the streaming data and proximity and touch events cannot be detected. The device will only briefly remain in this condition and it will be entered only when relatively large shifts in the counts has been detected.

The automatic ATI function aims to maintain a constant count value, regardless of the capacitance of the sense electrode (within the maximum range of the device).

The effects of auto-ATI on the application are the following:

- Automatic adjustment of the device configuration and processing parameters for a wide range of PCB and application designs to maintain an optimal configuration for proximity and touch detection.
- Automatic tuning of the sense electrodes at start-up to optimise the sensitivity of the application.
- Automatic re-tuning when the device detects changes in the sense electrodes capacitance to accommodate a large range of changes in the environment of the application that influences the sensing electrodes.
- Re-tuning only occurs during device operation when a relatively large sensitivity reduction is detected. This is to ensure smooth operation of the device during operation.
- Re-tuning may temporarily influences the normal functioning of the device, but

in most instances the effect will be hardly noticeable.

- Shortly after the completion of the re-tuning process the sensitivity of Proximity detection may be reduced slightly for a few seconds as internal filters stabilises.

Automatic ATI can be implemented so effectively due to:

- Excellent system signal to noise ratio (SNR).
- Effective digital signal processing to remove AC and other noise.
- The very stable core of the devices.
- The built in capability to accommodate a large range of sensing electrode capacitances.

10.2 Partial ATI

If the ATI Select bit is set (to Partial), the touch threshold for CH1 is the same as for CH0 & CH2 (see Section 7.2, CH1 touch threshold is now also set in Bank 0). If the ATI bit is not set (default), CH1 has its own touch threshold. The same applies to the Proximity channel's base value, which is not set in the first two bits of Bank 0 anymore. Instead, the first 5 bits of Bank 0, changes to Multiplier bits (both Sensitivity and Compensation) as follow:

Configuration: Bank1 bit 2-0

Comp2:Comp0: Compensation Multiplier

Bit	Selection
000	0
001	1
010	2
011	3
100	4
101	5
110	6
111	7



Configuration: Bank0 bit1-0

Base1:Base0: Sensitivity Multiplier

Bit	Selection
00	0
01	1
10	2
11	3

11 Specifications

11.1 Absolute Maximum Specifications

The following absolute maximum parameters are specified for the device:

Exceeding these maximum specifications may cause damage to the device.

- Operating temperature -40°C to 85°C
- Supply Voltage (VDDHI – GND) 5.5V
- Maximum pin voltage VDDHI + 0.5V
- Maximum continuous current (for specific Pins)
- Minimum pin voltage GND - 0.5V
- Minimum power-on slope 100V/s
- ESD protection ±3kV

Table 11.1 IQS133 General Operating Conditions

DESCRIPTION	Conditions	PARAMETER	MIN	TYP	MAX	UNIT
Supply voltage		V _{DDHI}	2.95	3.3	5.50	V
Internal regulator output	2.95 ≤ V _{DDHI} ≤ 5.0	V _{REG}	2.35	2.50	2.65	V
Boost operating current	2.95 ≤ V _{DDHI} ≤ 5.0	I _{IQS133_BP}		220		µA
Normal operating current	3.3V	I _{IQS133_NP}		17.5		µA
Low power operating current	3.3V	I _{IQS133_LP1}		6.3		µA
Low power operating current	3.3V	I _{IQS133_LP2}		4.8		µA
Low power operating current	3.3V	I _{IQS133_LP3}		4.3		µA
Low power operating current	3.3V	I _{IQS133_LP4}		4		µA
Low power operating current	3.3V	I _{IQS133_LP5}		3.8		µA
Low power operating current	3.3V	I _{IQS133_LP6}		<3.5		µA



Table 11.2 IQS133Z General Operating Conditions

DESCRIPTION	Conditions	PARAMETER	MIN	TYP	MAX	UNIT
Supply voltage		V _{DDHI}	2.95	3.3	5.50	V
Internal regulator output	2.95 ≤ V _{DDHI} ≤ 5.0	V _{REG}	2.35	2.50	2.65	V
Boost operating current	2.95 ≤ V _{DDHI} ≤ 5.0	I _{IQS133Z_BP}		220		μA
Normal operating current	3.3V	I _{IQS133Z_NP}		32.5		μA
Low power operating current	3.3V	I _{IQS133Z_LP1}		11		μA
Low power operating current	3.3V	I _{IQS133Z_LP2}		7.9		μA
Low power operating current	3.3V	I _{IQS133Z_LP3}		6.9		μA
Low power operating current	3.3V	I _{IQS133Z_LP4}		6.44		μA
Low power operating current	3.3V	I _{IQS133Z_LP5}		6		μA
Low power operating current	3.3V	I _{IQS133Z_LP6}		<6		μA

Table 11.3 Start-up and shut-down slope Characteristics

DESCRIPTION	Conditions	PARAMETER	MIN	MAX	UNIT
POR	V _{DDHI} Slope ≥ 100V/s	POR	0.92	2.3	V
BOD		BOD	1	1.54	V

Table 11.4 POUT and TOUT Characteristics

Symbol	Description	I _{SOURCE} (Total)	Conditions	MIN	TYP	MAX	UNIT
V _{OH}	Output High voltage	16.5mA	V _{DDHI} = 5V		4.72		V
		9.8mA	V _{DDHI} = 3V		2.8		
Symbol	Description	I _{SINK} (Total)	Conditions	MIN	TYP	MAX	UNIT
V _{OL}	Output Low voltage	16mA	V _{DDHI} = 5V		0.48		V
		9mA	V _{DDHI} = 3V		0.36		



Table 11.5 Initial Touch Times

DESCRIPTION	PARAMETER	MIN	MAX	Unit
BP ¹	Report Rate	45	79	ms
NP	Report Rate	54	102	ms
LP6	Report Rate	54	2099	ms

Table 11.6 Repetitive Touch Rates

DESCRIPTION	Conditions	PARAMETER	Sample rate = 5ms	Sample rate = 9ms	UNIT
All power modes	Zoom active	Response Rate ²	>15	>6.5	Touches/second

¹ Communication and charge frequency to comply with sample rate as reported earlier in this datasheet.

² Debounce of 2 (up and down)



12 Mechanical Dimensions

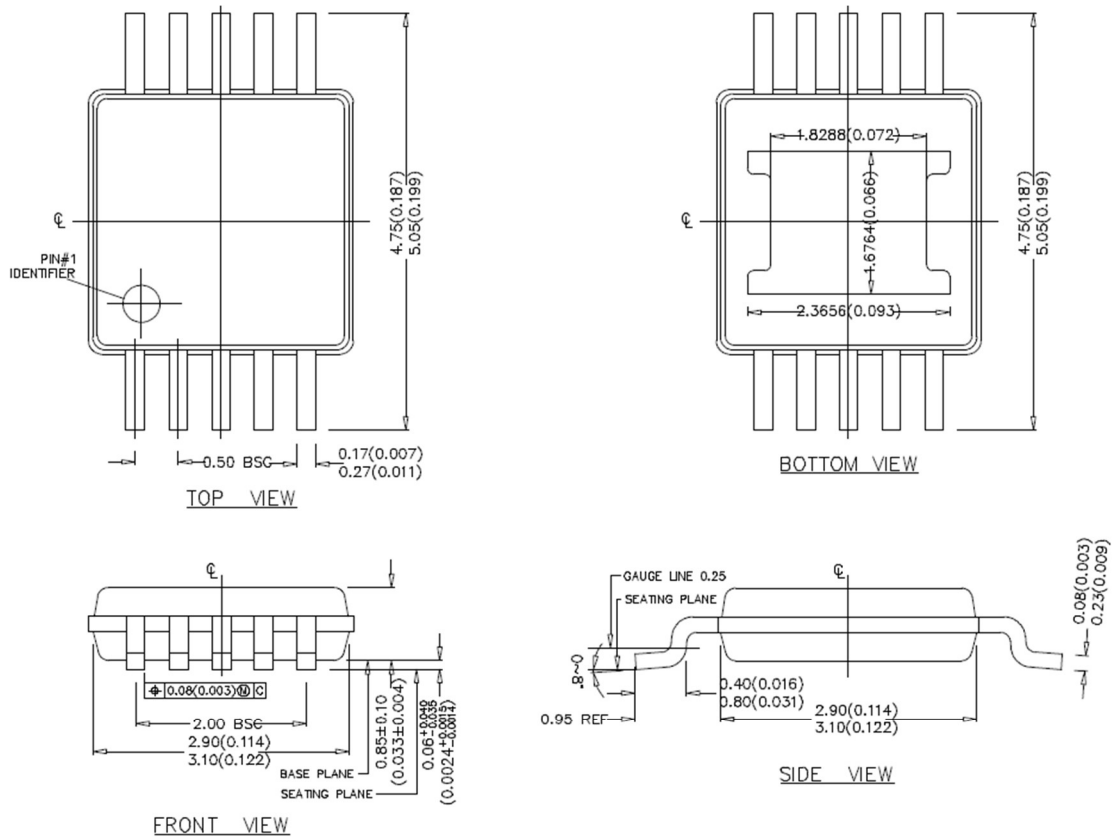

NOTES:

- 1) THIS DRAWING IS FOR CUSTOMER PURPOSE.
- 2) LEADFRAME MATERIAL : C7025 (THICKNESS: 0.15MM).
- 3) BOTH PACKAGE LENGTH & WIDTH DO NOT INCLUDE MOLD FLASH.
- 4) FORMED LEAD SHALL BE PLANAR WITH RESPECT TO ONE ANOTHER WITHIN 0.10MM.
- 5) UNREMOVED FLASH BETWEEN LEADS & PACKAGE END FLASH SHALL NOT EXCEED 0.15MM FROM BOTTOM BODY.
- 6) CONTROLLING DIMENSION : MM(INCH).

Figure 12.1 MSOP-10 Package Dimensions.

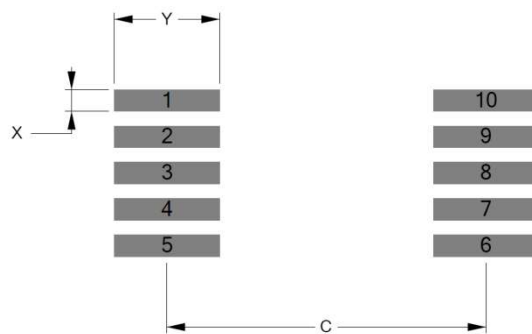

Figure 12.2 MSOP-10 Footprint.



Table 12.1 MSOP-10 Footprint Dimensions from Figure 12.2.

Dimension	[mm]
Pitch	0.50
C	4.40
Y	1.45
X	0.30



12.2 Package MSL

Moisture Sensitivity Level (MSL) relates to the packaging and handling precautions for some semiconductors. The MSL is an electronic standard for the time period in which a moisture sensitive device can be exposed to ambient room conditions (approximately 30°C/85%RH see J-STD033C for more info) before reflow occur.

Table 12.2 MSL

Package	Level (duration)
MSOP-10	MSL 1 (Unlimited at ≤30 °C/85% RH) Reflow profile peak temperature < 260 °C for < 25 seconds Number of Reflow ≤ 3

13 Device Marking

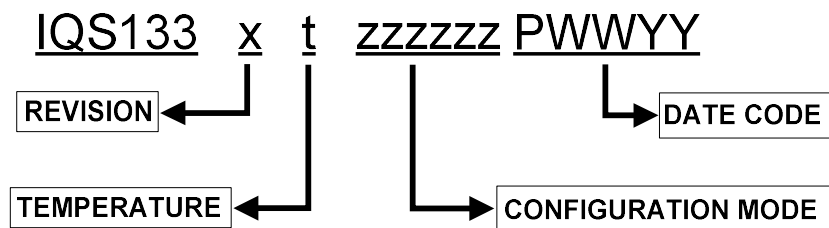

REVISION	x	=	IC Revision Number
TEMPERATURE RANGE	t	=	I -40°C to 85°C (Industrial) C 0°C to 70°C (Commercial)
IC CONFIGURATION¹	zzzzzz	=	Configuration (Hexadecimal)
DATE CODE	P	=	Package House
	WW	=	Week
	YY	=	Year

¹ Configuration marking on the bottom of the IC



14 Ordering Information

Orders will be subject to a MOQ (Minimum Order Quantity) of a full reel. Contact the official distributor for sample quantities. A list of the distributors can be found under the “Distributors” section of www.azoteq.com.

For large orders, Azoteq can provide pre-configured devices.

The Part-number can be generated by using USBProg.exe or the Interactive Part Number generator on the website.

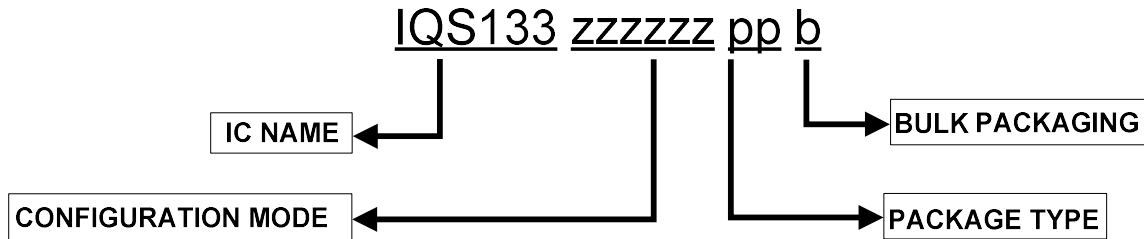

IC NAME	IQS133	=	IQS133
CONFIGURATION	zzzzzz	=	IC Configuration (hexadecimal)
PACKAGE TYPE	MS	=	MSOP-10
BULK PACKAGING	R	=	Reel (4000pcs/reel) – MOQ = 4000pcs
	T	=	Tube (96pcs/tube, Special Order)



15 Revision History

The limitations for specific revision numbers are described below:

Revision	Device ID	Package Markings	Limitations
0	1901	IQS133 ENG 23010	<ul style="list-style-type: none">CX floating between conversions
1	1902 110D	IQS133 25110 21211	<ul style="list-style-type: none">High sensitivity at start up. Suggested $P_{TH} = 8$ (default = 2 may trigger PO on start-up or LP exit in selected applications)
2	1903	IQS 133Z 23311	<ul style="list-style-type: none">Low power limitation, down to sub 8uA only.



Contact Information

	USA	Asia	South Africa
Physical Address	11940 Jollyville Suite 120-S Austin TX 78759 USA	Room 501A, Block A, T-Share International Centre, Taoyuan Road, Nanshan District, Shenzhen, Guangdong, PRC	1 Bergsig Avenue Paarl 7646 South Africa
Postal Address	11940 Jollyville Suite 120-S Austin TX 78759 USA	Room 501A, Block A, T-Share International Centre, Taoyuan Road, Nanshan District, Shenzhen, Guangdong, PRC	PO Box 3534 Paarl 7620 South Africa
Tel	+1 512 538 1995	+86 755 8303 5294 ext 808	+27 21 863 0033
Email	info@azoteq.com	info@azoteq.com	info@azoteq.com

*Visit www.azoteq.com
for a list of distributors and worldwide representation*

Patents as listed on www.azoteq.com/patents-trademarks/ may relate to the device or usage of the device.

Azoteq®, Crystal Driver®, IQ Switch®, ProxSense®, ProxFusion®, LightSense™, SwipeSwitch™, and the  logo are trademarks of Azoteq.

The information in this Datasheet is believed to be accurate at the time of publication. Azoteq uses reasonable effort to maintain the information up-to-date and accurate, but does not warrant the accuracy, completeness or reliability of the information contained herein. All content and information are provided on an “as is” basis only, without any representations or warranties, express or implied, of any kind, including representations about the suitability of these products or information for any purpose. Azoteq disclaims all warranties and conditions with regard to these products and information, including but not limited to all implied warranties and conditions of merchantability, fitness for a particular purpose, title and non-infringement of any third party intellectual property rights. Azoteq assumes no liability for any damages or injury arising from any use of the information or the product or caused by, without limitation, failure of performance, error, omission, interruption, defect, delay in operation or transmission, even if Azoteq has been advised of the possibility of such damages. The applications mentioned herein are used solely for the purpose of illustration and Azoteq makes no warranty or representation that such applications will be suitable without further modification, nor recommends the use of its products for application that may present a risk to human life due to malfunction or otherwise. Azoteq products are not authorized for use as critical components in life support devices or systems. No licenses to patents are granted, implicitly, express or implied, by estoppel or otherwise, under any intellectual property rights. In the event that any of the abovementioned limitations or exclusions does not apply, it is agreed that Azoteq’s total liability for all losses, damages and causes of action (in contract, tort (including without limitation, negligence) or otherwise) will not exceed the amount already paid by the customer for the products. Azoteq reserves the right to alter its products, to make corrections, deletions, modifications, enhancements, improvements and other changes to the content and information, its products, programs and services at any time or to move or discontinue any contents, products, programs or services without prior notification. For the most up-to-date information and binding Terms and Conditions please refer to www.azoteq.com.